

Art. Nr. 1912096
1/10







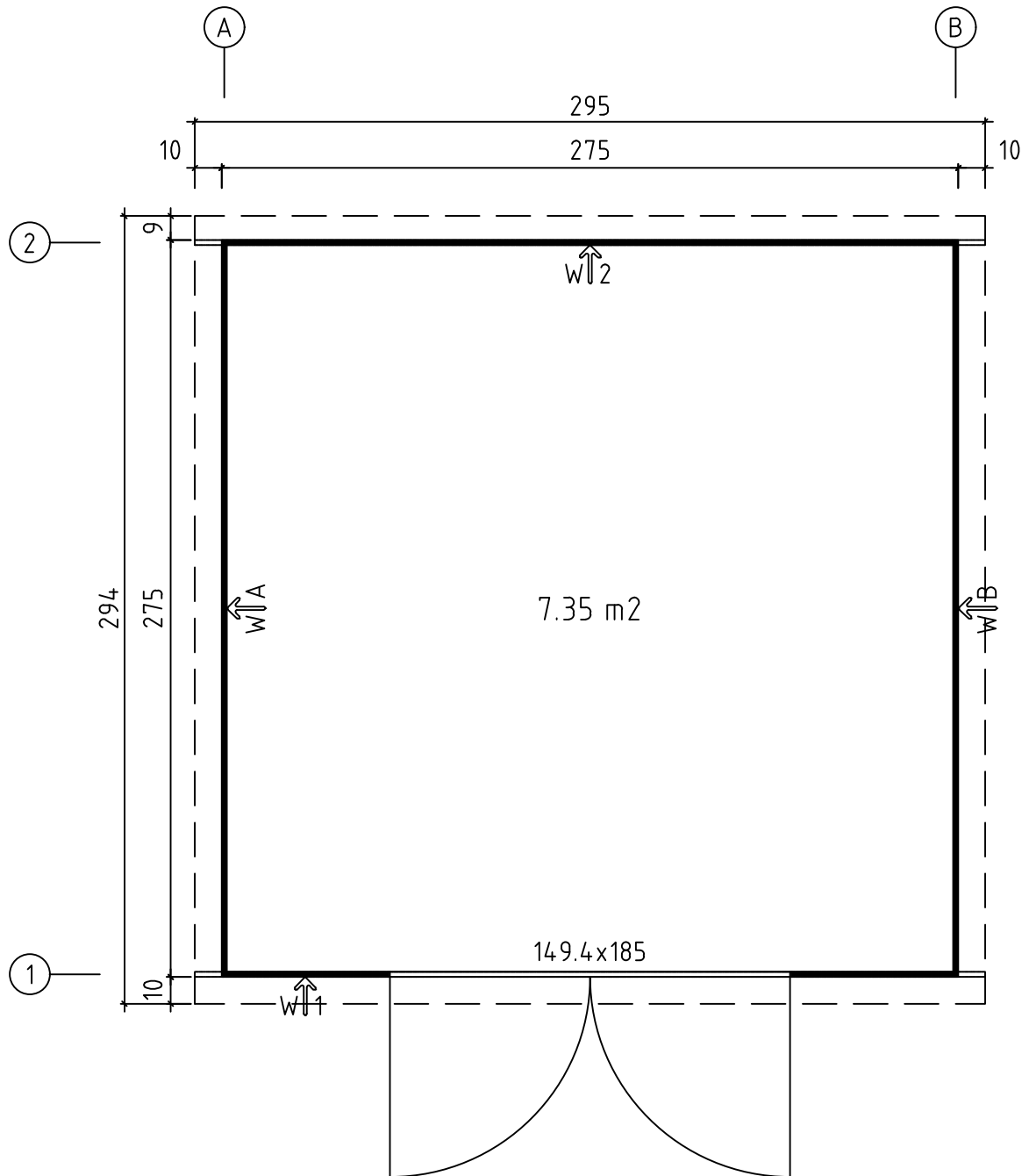

05.02.2026

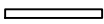
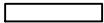
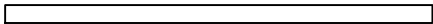
Art. Nr. 1912096

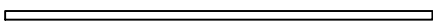
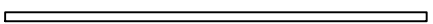
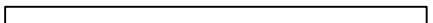
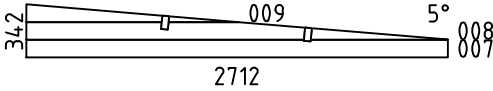
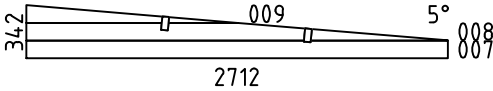
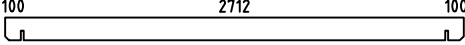
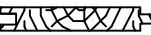
Groundplan - Grundplan - Plan de masse - Planimetria -
Plattegrond - Põhiplaan

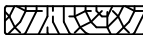
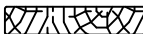
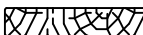
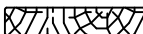

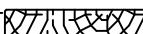
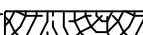
Pos	Piece list - Stückliste - Liste des pièces - Elementi - Stuklijst - Elementos - Tükítabel 05.02.2026 Art. Nr. 1912096	Q	P (mm)	L (mm)
001 52735		2	19x57	623
002 52733		32	19x114	623
003 52734		16	19x114	2750
004 52736		2	19x114	2950
005 52737		1	19x57	2750
006 52738		2	19x57	2712
007 52739		30	19x114	2712
WA-1 52741		1		
WB-1 52741		1		
A-PR1 52743	Roof beam - Dachbalken - Panne de toit - Perlina del tetto - Gordingen / dakbalk - Correa - Pärilin 	2	44x146	2950
RB-1 38384	Roof boards - Dachbretter - Voliges - Perlina per tetto - Dakhout - Tablero de tejado - Katuselaud 	33	90x15.5	2950
DPL-1 46308	Roofing felt fillet - Dachpappenleiste - Baguette de fixation du feutre bitumeux - Asse per fissaggio guaina bituminosa - Afdeklijst asfaltpapier - Moldura de fieltro para tejado - Katusepapiiliist 	1	15x45	2980
DPL-2 34957	Roofing felt fillet - Dachpappenleiste - Baguette de fixation du feutre bitumeux - Asse per fissaggio guaina bituminosa - Afdeklijst asfaltpapier - Moldura de fieltro para tejado - Katusepapiiliist 	2	15x45	3000
TBE7-1 39886	Corner fillet - Deckleiste - Profils de finition angles a l'exterieur - Massello d'angolo - (hoek)lijst - Moldura de esquina - Nurgaliist 	2	15x70	1767
TBE7-2 23516	Corner fillet - Deckleiste - Profils de finition angles a l'exterieur - Massello d'angolo - (hoek)lijst - Moldura de esquina - Nurgaliist 	2	15x70	1881
TBE7-3 39988	Corner fillet - Deckleiste - Profils de finition angles a l'exterieur - Massello d'angolo - (hoek)lijst - Moldura de esquina - Nurgaliist 	2	15x70	1995
TBE7-4 23517	Corner fillet - Deckleiste - Profils de finition angles a l'exterieur - Massello d'angolo - (hoek)lijst - Moldura de esquina - Nurgaliist 	2	15x70	2109
P2-1 47670	Post - Pfosten - Poteau - Piede registrabile - Stijl - Poste - Post 	2	44x44	1870
P2-2 42239	Post - Pfosten - Poteau - Piede registrabile - Stijl - Poste - Post 	2	44x44	2100
TB3-1 34958	Fascia board - Traufbrett - Bandeau de toit - Finitura lati tetto - Gevellijst - Tablero de alero - Räästalaud 	1	15x120	2980
TB3-2 39249	Fascia board - Traufbrett - Bandeau de toit - Finitura lati tetto - Gevellijst - Tablero de alero - Räästalaud 	2	15x120	3000

Art. Nr. 1912096

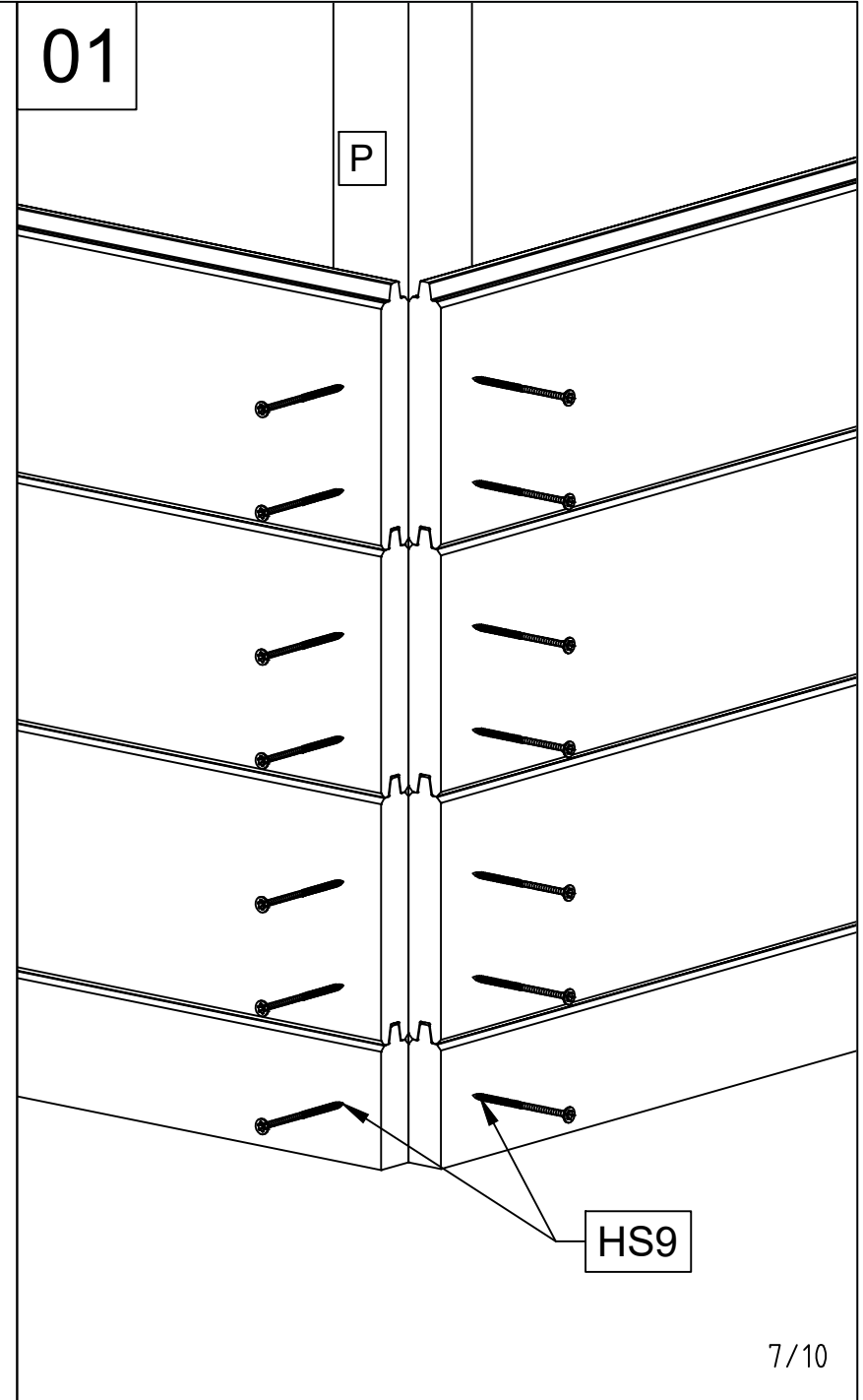
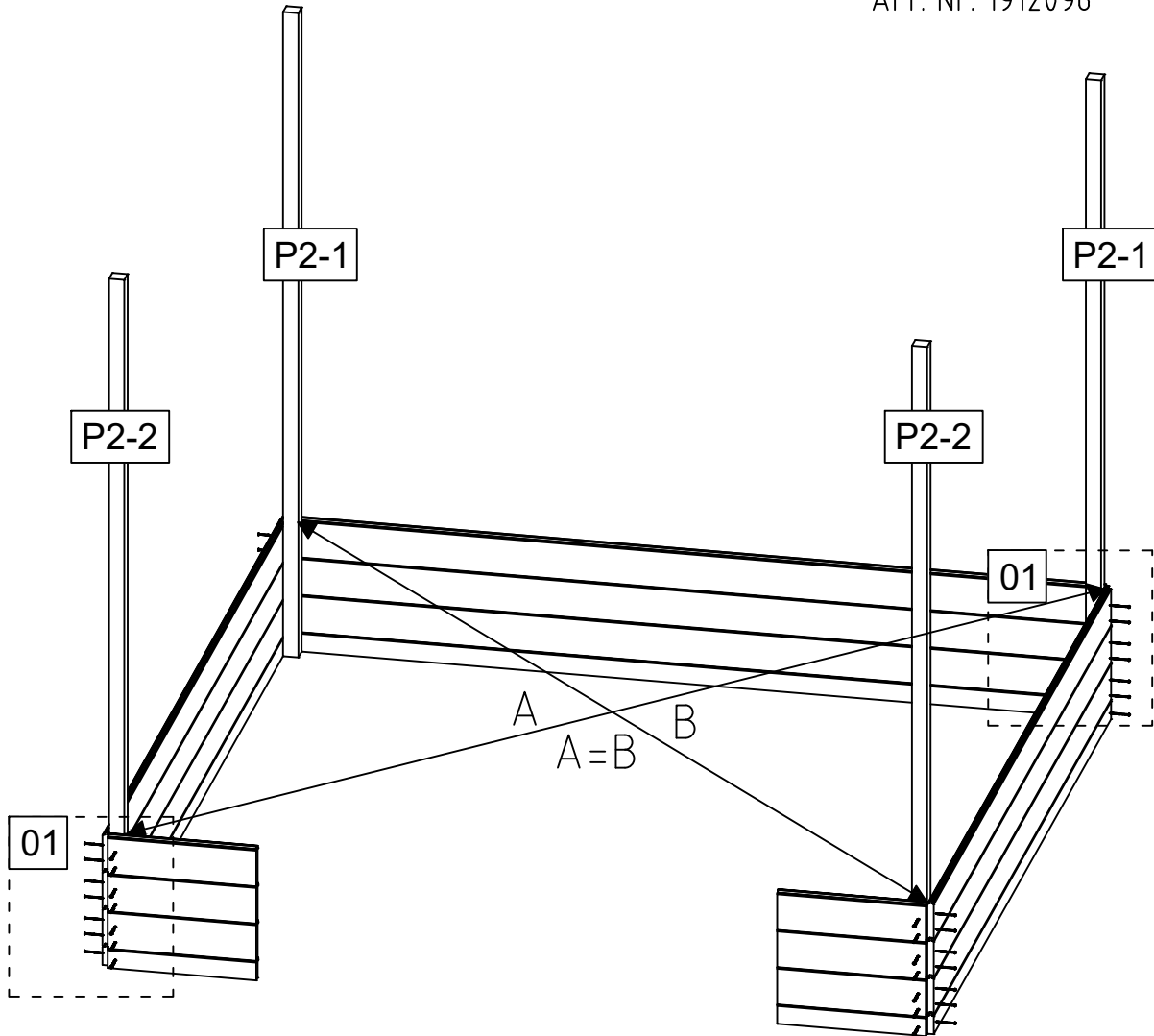

Art. Nr. 1912096

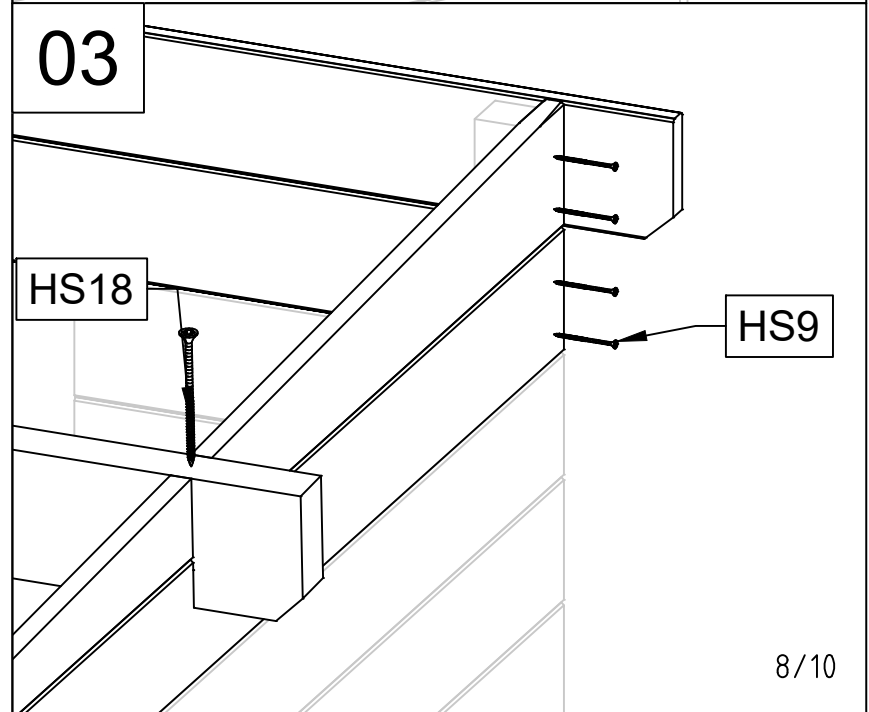
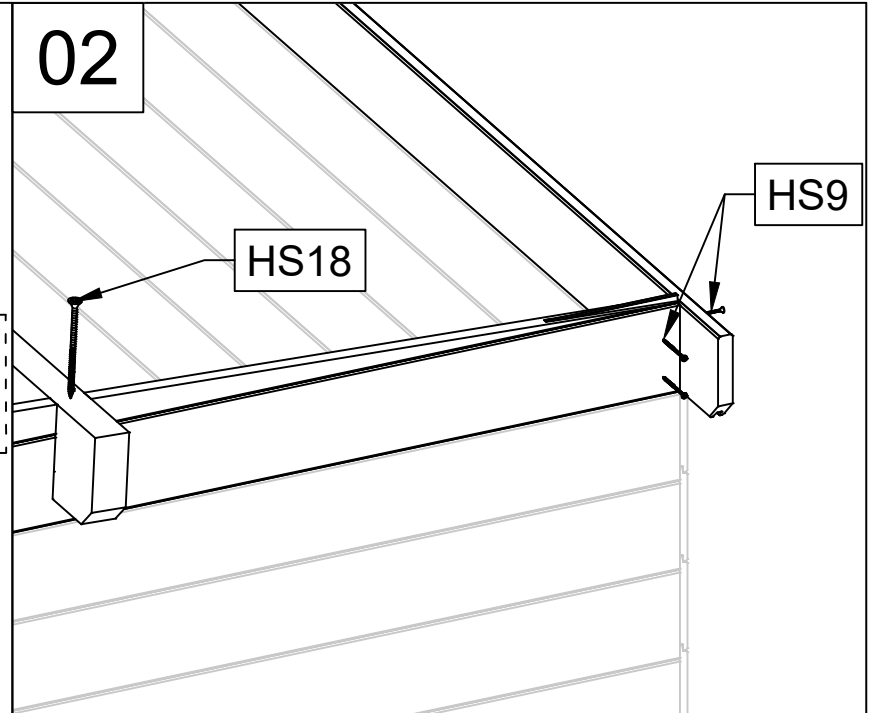
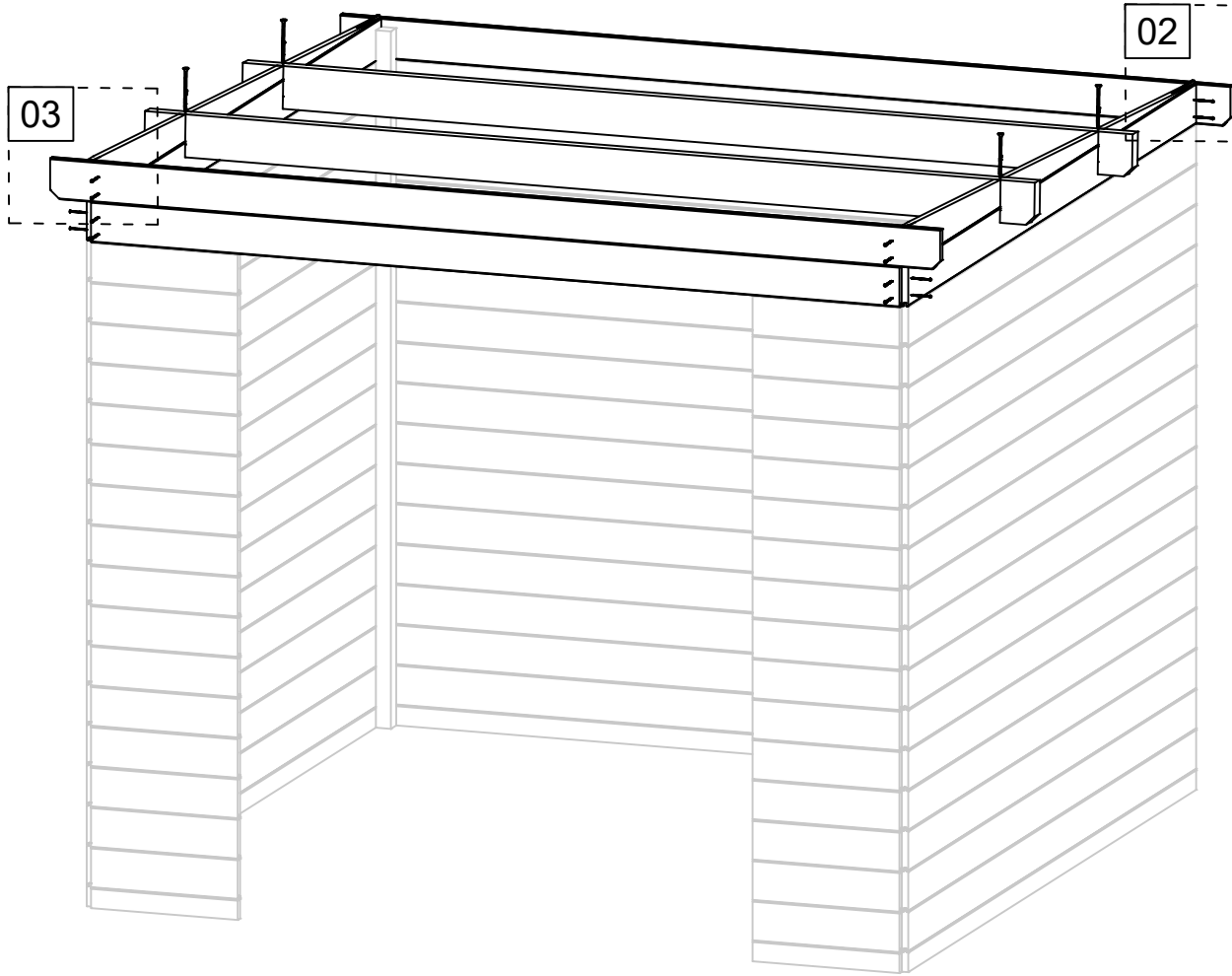



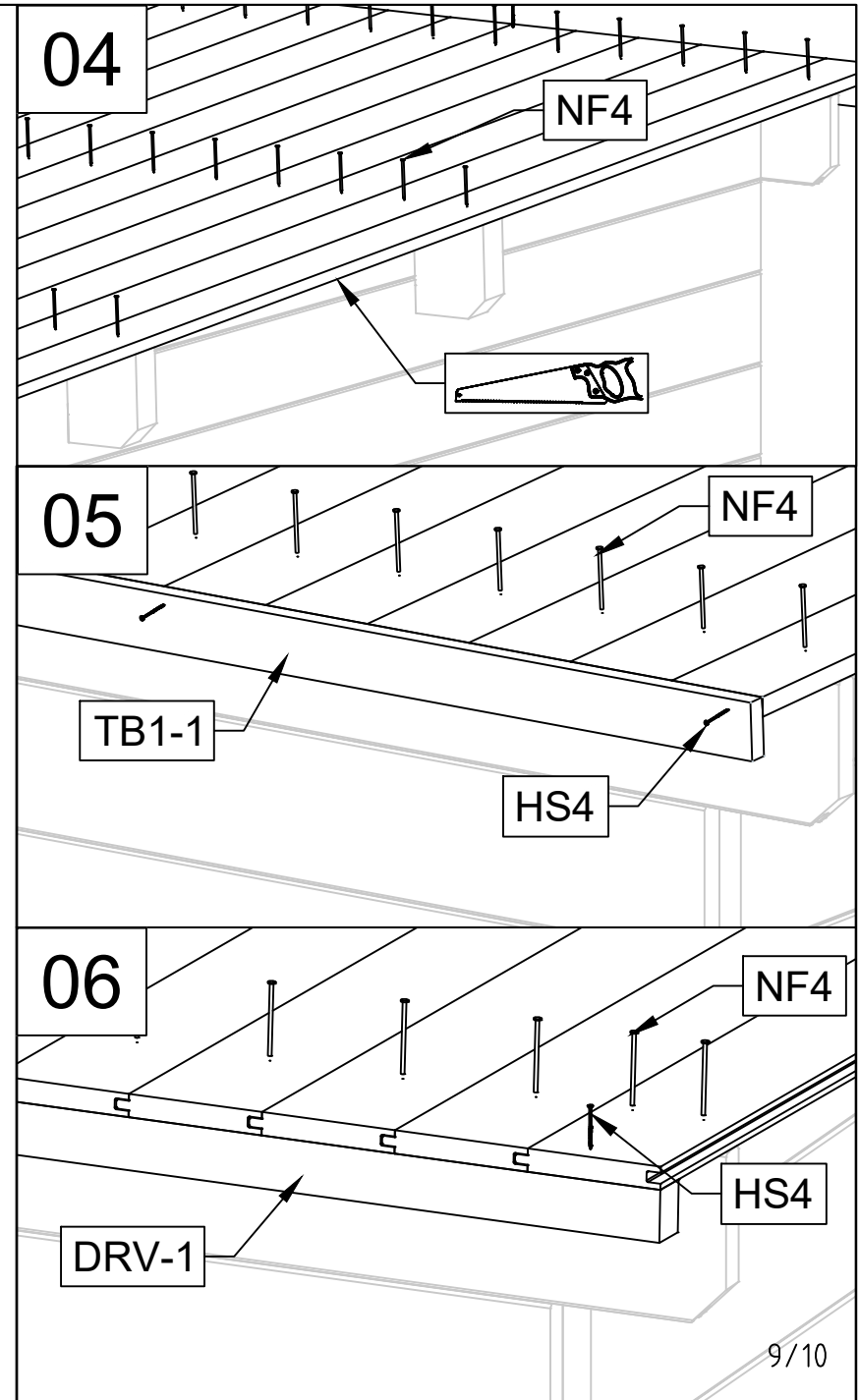
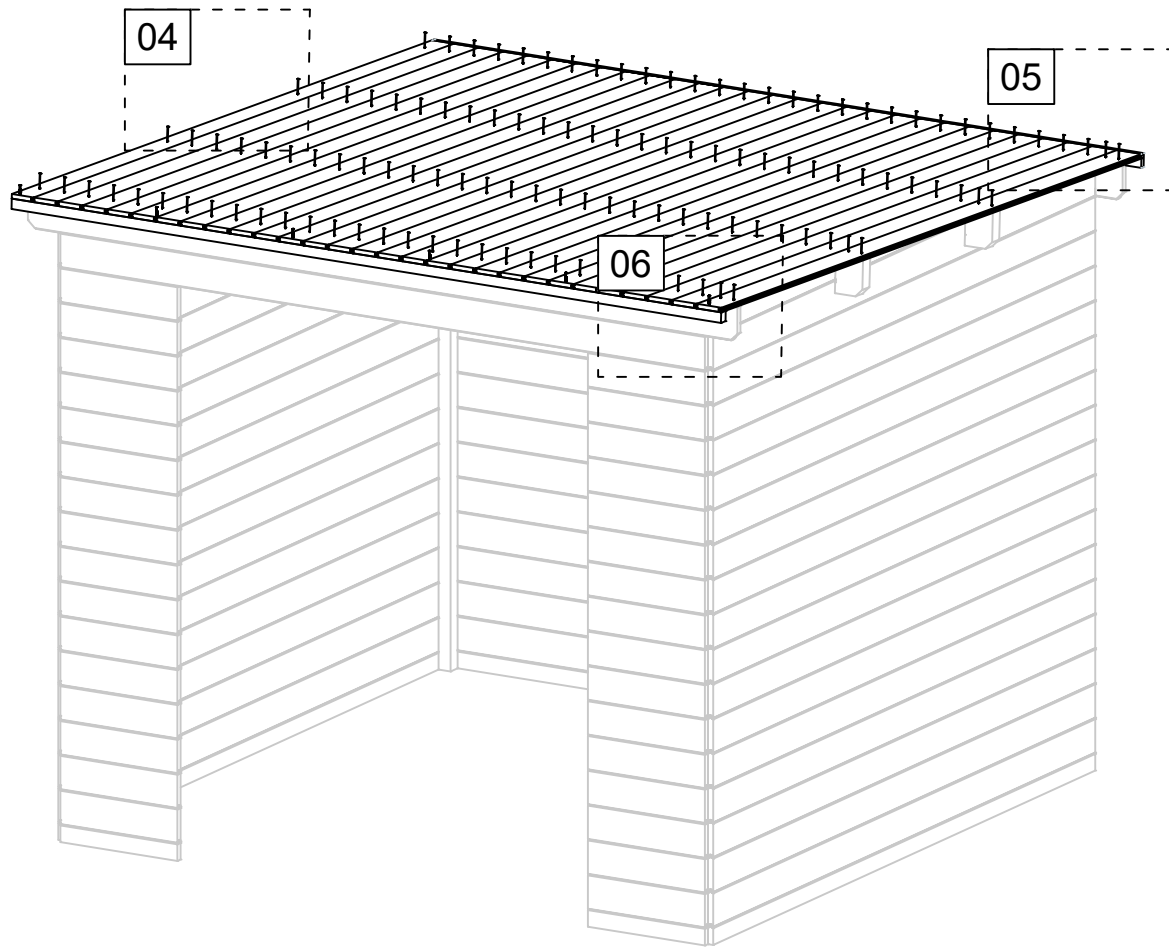



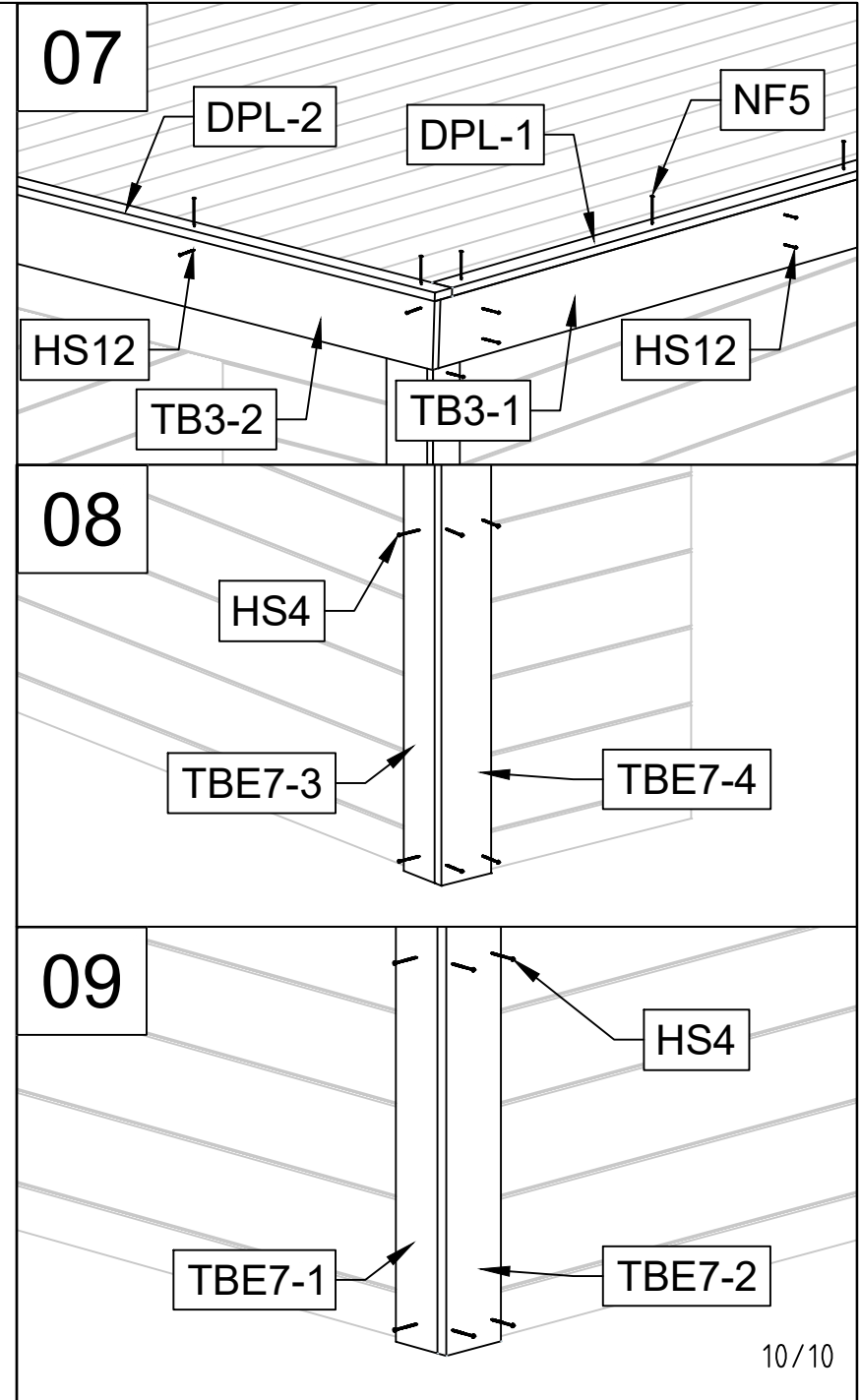
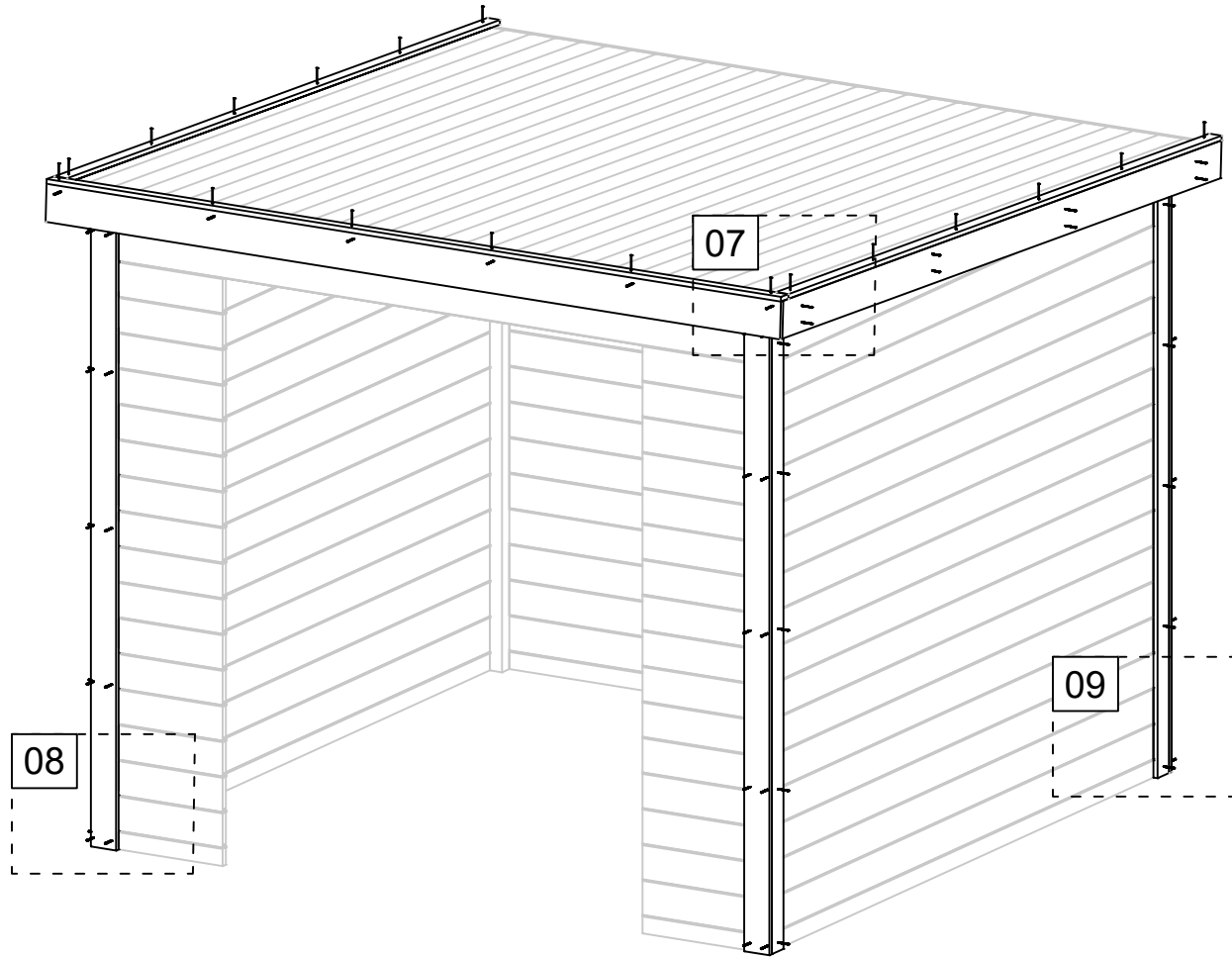

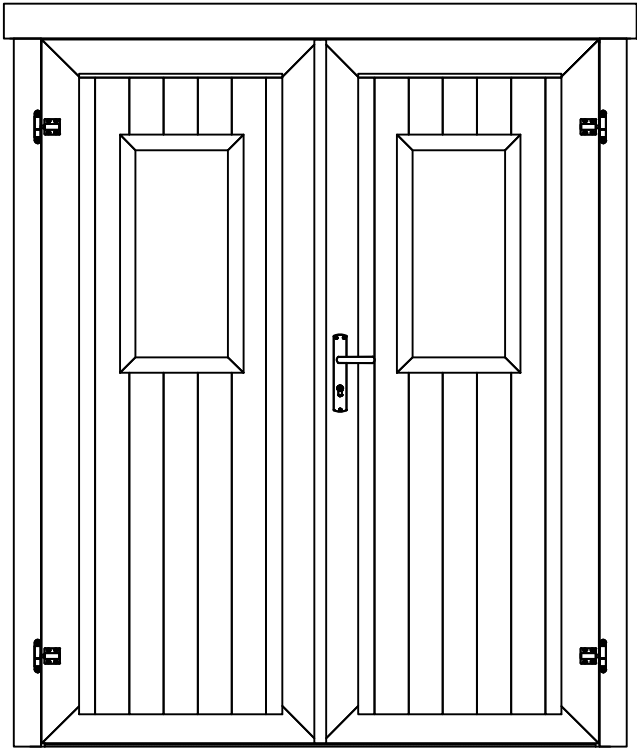
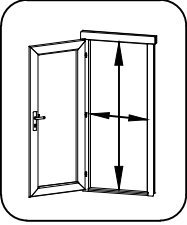

Art. Nr. 1912096



Art. Nr. 1912096



Pos	25.11.2025 Piece list - Stückliste - Liste des pièces - Elementi - Stuklijst - Tükitalabel 1494x1850 TUK.2.010.XVP.MMX19 XGA+28	1/2	Q	P (mm)	L (mm)
	Glass size - Glasgröße - Taille de la vitre - Misura del vetro - Glas afmeting - Klaasi mõõt: 262x549 mm				
	  <p>1418x1794 mm</p>				
1	Upper door jamb - Türrahmen oben - Cadre de porte supérieur - Telaio superiore della porta - Bovendorpel - Ukse ülemine leng		1	66x100	1628
2	Left door jamb - Türrahmen links - Cadre de porte gauche - Telaio montante sinistro della porta - Linkerstijl deurframe - Ukse vasak leng		1	66x80	1850
3	Right door jamb - Türrahmen rechts - Cadre de porte droit - Telaio montante destro della porta - Rechterstijl deurframe - Ukse parem leng		1	66x80	1850
4	Doorstep - Swelle - Barre de seuil - Soglia della porta - Deurdorpel - Lävepak		1	18x18	1418
5	Connection strip - Deckleiste - Baguette de battement - Profilo verticale della porta - Stulpiljst - kokkuvaltsiliist		1	13x30	1812
6	Window fillet - Glasleiste - Cadre de vitre - listello per finstra - Glaslijst - Klaasiliist		4	20x40	318
7	Window fillet - Glasleiste - Cadre de vitre - listello per finstra - Glaslijst - Klaasiliist		4	20x40	613
8	Window fillet - Glasleiste - Cadre de vitre - listello per finstra - Glaslijst - Klaasiliist		4	10x40	318
9	Window fillet - Glasleiste - Cadre de vitre - listello per finstra - Glaslijst - Klaasiliist		4	10x40	613
10	Glass - Glas - Vitre - Vetro - Glas - Klaas		2		

